

Table of Contents

Health and Safety Precautions	3
General Use Precautions	3
1. Introduction	5
1.1. Minimum System Requirements	6
1.2. Box Content	7
1.3. Views of the Drive	8
1.3.1. Front View	8
1.3.2. 2big Triple Rear View	9
1.4. Cables and Connectors	10
1.4.1. Hi-Speed USB 2.0	10
1.4.2. FireWire	10
2. Setting Up Your LaCie 2big	11
2.1. Connecting the Interface Cable	12
2.2. Turning the Drive On	13
2.3. Formatting	14
2.3.1. File System Formats	14
2.3.2. Formatting for Windows Users	16
2.3.3. Formatting for Mac Users	18
2.4. Installing New Firmware (Upgrade)	19
3. RAID	20
3.1. About 2big Triple RAID Modes	20
3.1.1. FAST (RAID 0)– Preconfigured mode of the 2big	20
3.1.2. BIG (Concatenation)	21
3.1.3. JBOD	21
3.1.4. SAFE 100 (RAID 1)	22
3.2. Changing the RAID Mode	23
3.3. Partitioning the Disks	24
3.3.1. Windows Users	24
3.3.2. Mac Users	28
3.4. Removing and Installing Drives	29
4. Troubleshooting	30
4.1. Fan	30
4.2. LED Indicators	31
4.3. LaCie 2big Host Connection	32
5. Contacting Customer Support	33
LaCie Technical Support Contacts	34
6. Warranty	35

Copyrights

Copyright © 2007 LaCie. All rights reserved. No part of this publication may be reproduced, stored in a retrieval system, or transmitted in any form or by any means, electronic, mechanical, photocopying, recording or otherwise, without the prior written consent of LaCie.

Trademarks

Apple, Mac, and Macintosh are registered trademarks of Apple Inc. Microsoft, Windows 98, Windows 98 SE, Windows 2000, Windows Millennium Edition, Windows XP and Windows Vista are registered trademarks of Microsoft Corporation. Other trademarks mentioned in this manual are the property of their respective owners.

Changes

The material in this document is for information only and subject to change without notice. While reasonable efforts have been made in the preparation of this document to assure its accuracy, LaCie assumes no liability resulting from errors or omissions in this document, or from the use of the information contained herein. LaCie reserves the right to make changes or revisions in the product design or the product manual without reservation and without obligation to notify any person of such revisions and changes.

Canada Compliance Statement

This Class B digital apparatus meets all requirements of the Canadian Interference-Causing Equipment Regulations.

Japan Compliance Statement

This is a Class B product based on the standard of the Voluntary Control Council for Interference from Information Technology Equipment (VCCI). If this is used near a radio or television receiver in a domestic environment, it may cause radio interference. Install and use the equipment according to the instruction manual.



FCC Statement

This device complies with Part 15 of the FCC Rules. Operation is subject to the following conditions:

1. The devices may not cause harmful interference
2. The devices must accept any interference received, including interference that may cause undesired operation.

NOTE: This equipment has been tested and found to comply with the limits for a Class B digital device, pursuant to Part 15 of the FCC Rules. These limits are designed to provide reasonable protection against harmful interference in a residential installation. This equipment generates, uses and can radiate radio frequency energy and, if not installed and used in accordance with the instructions, may cause harmful interference to radio communications. However, there is no guarantee that interference will not occur in a particular installation. If this equipment does cause harmful interference to radio or television reception,

which can be determined by turning the equipment off and on, the user is encouraged to try and correct the interference by one or more of the following measures:

- ❖ Reorient or relocate the receiving antenna.
- ❖ Increase the separation between the equipment and receiver.
- ❖ Connect the equipment into an outlet on a circuit different from that to which the receiver is connected.
- ❖ Consult the dealer or an experienced radio/TV technician for help.

Modifications to this product not authorized by LaCie could void the FCC & Industry Canada regulations and negate your authority to operate the product.

CAUTION: Modifications not authorized by the manufacturer may void the user's authority to operate this device.

CE Manufacturer's Declaration for CE Certification

We, LaCie, solemnly declare that this product conforms to the following European standards: Class B EN60950, EN55022, EN55024, EN61000-3-2: 2000, EN61000-3-3: 2001

With reference to the following conditions: 73/23/EEC Low Voltage Directive; 89/336/EEC EMC Directive



This symbol on the product or on its packaging indicates that this product must not be disposed of with your other household waste. Instead, it is your responsibility to dispose of your waste equipment by handing it over to a designed collec-

tion point for the recycling of waste electrical and electronic equipment. The separate collection and recycling of your waste equipment at the time of disposal will help to conserve natural resources and ensure that it is recycled in a manner that protects human health and the environment. For more

information about where you can drop off your waste equipment for recycling, please contact your local city office, your household waste disposal service, or the shop where you purchased the product.

Health and Safety Precautions

- ❖ Only qualified persons are authorized to carry out maintenance on this device.
- ❖ Read this User Manual carefully and follow the correct procedure when setting up the device.
- ❖ Do not open a disk drive or attempt to disassemble or modify it. Never insert any metallic object into the drive to avoid any risk of electrical shock, fire, short-circuiting or dangerous emissions. The disk drives shipped with your LaCie 2big contain no user-serviceable parts. If it appears to be malfunctioning, have it inspected by a qualified LaCie Technical Support representative.
- ❖ Never expose your device to rain, or use it near water, or in damp or wet conditions. Never place objects containing liquids on the LaCie 2big, as they may spill into its openings. Doing so increases the risk of electrical shock, short-circuiting, fire or personal injury.
- ❖ Make sure that the computer and LaCie 2big are electrically grounded. If the devices are not grounded, there is an increased risk of electrical shock. Power requirements 100-240 V~, 1.5 A, 60-50 Hz, (Supply voltage fluctuations not exceeding $\pm 10\%$ of the nominal, transient over-voltages according to over-voltage category II).

General Use Precautions

- ❖ Power requirements 100-240 V~, 1.5 A, 50-60 Hz, (supply voltage fluctuations not exceeding $\pm 10\%$ of the nominal and transient over-voltages according to over-voltage category II).
- ❖ Do not expose the LaCie 2big to temperatures outside the range of 5° C to 35° C (41° F to 95° F); or to operational humidity beyond 5-80%, non-condensing, or non-operating humidity beyond 10-90%, non-condensing. Doing so may damage the LaCie 2big or disfigure its casing. Avoid placing your LaCie 2big near a source of heat or exposing it to sunlight (even through a window). Inversely, placing your LaCie 2big in an environment that is too cold may damage the unit.
- ❖ Rated cooling for altitudes up to 2000 meters.
- ❖ Always unplug the LaCie 2big from the electrical outlet if there is a risk of lightning or if it will be unused for an extended period of time. Otherwise, there is an increased risk of electrical shock, short-circuiting or fire.
- ❖ Use only the power supply shipped with the device.
- ❖ Do not use the LaCie 2big near other electrical appliances such as televisions, radios or speakers. Doing so may cause interference which will adversely affect the operation of the other products.
- ❖ Do not place the LaCie 2big near sources of magnetic interference, such

as computer displays, televisions or speakers.

- ❖ Magnetic interference can affect the operation and stability of your LaCie 2big.
- ❖ Do not place heavy objects on top of the LaCie 2big.
- ❖ Never use excessive force on your LaCie 2big. If you detect a problem, consult the Troubleshooting section in this manual.
- ❖ Protect your LaCie 2big from excessive exposure to dust during use or storage. Dust can build up inside

the device, increasing the risk of damage or malfunction.

- ❖ Never use benzene, paint thinners, detergent or other chemical products to clean the outside of the LaCie 2big. Such products will disfigure and discolor the casing. Instead, use a soft, dry cloth to wipe the device.
- ❖ Please replace defective hard drives only with a new drive provided by LaCie. For drive removal process, see section [3.4 Removing and Installing Drives](#).

CAUTION: The LaCie 2big warranty may be void as a result of the failure to respect the precautions listed above.

CAUTION: Drive warranty will be void if you replace a defective drive with a drive not purchased from LaCie.

IMPORTANT INFO: Any loss, corruption or destruction of data while using a LaCie drive is the sole responsibility of the user, and under no circumstances will LaCie be held liable for the recovery or restoration of this data. To help prevent the loss of your data, LaCie highly recommends that you keep **TWO** copies of your data; one copy on your external hard drive, for instance, and a second copy either on your internal hard drive, another external hard drive or some other form of removable storage media. LaCie offers a complete line of CD and DVD drives. If you would like more information on backup, please refer to our website.

IMPORTANT INFO: 1GB = 1,000,000,000 bytes. 1TB = 1,000,000,000,000 bytes. Once formatted, the actual available storage capacity varies depending on operating environment (typically 5-10% less).

1. Introduction

Congratulations on the purchase of your new LaCie 2big Triple. This high-performance, extremely flexible RAID (Redundant Array of Independent/Inexpensive Disks) subsystem is ideally suited for integration with databases, imaging systems and e-mail and Web servers.

RAID technology is one of the best means to protect your data, while providing greater data integrity and availability than standard hard disk storage. With the ability to provide single error detection and redundant information to recover the original if a disk fails, a RAID system is an ideal means to safe-guard valuable data while also stream-lining performance.

The LaCie 2big is the ultimate approach to a flexible RAID solution, with its ability to manage various RAID levels for a wide range of applications.

■ Features

- ❖ Huge capacity, speed & security on demand
- ❖ Customizable – 6 easy to configure RAID modes: FAST, BIG, JBOD, SAFE 100
- ❖ High-performance storage
- ❖ Hi-Speed USB 2.0, FireWire 400 and FireWire 800
- ❖ Easy plug & play installation on PC or Mac

Quick Links

- Click to jump to a section:
- ❖ **Connecting** the Interface Cable
- ❖ **Turning** the Drive On
- ❖ **Changing** the RAID Mode



1.1. Minimum System Requirements



Windows Users

- ❖ Windows 2000, Windows XP, Windows Server 2003 or Windows Vista
- ❖ 500MHz Pentium III or higher (or equivalent processor)
- ❖ 512MB RAM or greater
- ❖ Available USB 2.0, FireWire 400 or FireWire 800* interface port



Mac Users

- ❖ Mac OS X 10.2.8 or later
- ❖ G4, G5, Intel Core Duo or Intel Core 2 Duo
- ❖ 512MB RAM or greater
- ❖ Available USB 2.0, FireWire 400 or FireWire 800* interface port

*Most computers do not come from the factory with FireWire 800 ports, so you may need to purchase a PCI, PCI-X or PCI-Express card to be able to connect your LaCie 2big via FireWire 800 interface. LaCie offers a wide selection of PCI cards. Visit the LaCie website at www.lacie.com/accessories.

TECHNICAL NOTE: To achieve USB 2.0 speeds, your drive must be connected to a USB 2.0 host port. If it is connected to a USB 1.0 port, your drive will operate at USB 1.0 speeds.

1.2. Box Content

Your LaCie 2big package contains the system tower and an accessories box containing the items listed below.

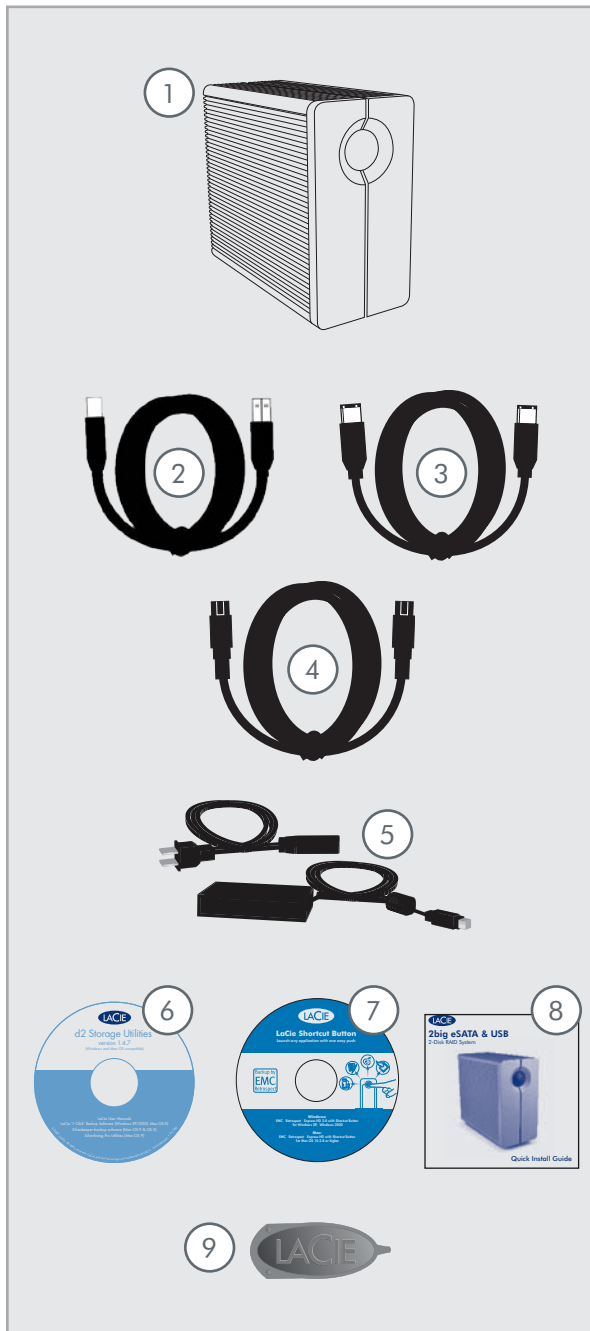

- ① LaCie 2big RAID system tower with two hot-swappable hard drives
- ② Hi-Speed USB 2.0 cable
- ③ FireWire 400 cable
- ④ FireWire 800 cable
- ⑤ External power supply
- ⑥ LaCie Utilities CD-ROM
- ⑦ LaCie Shortcut Button CD-ROM
- ⑧ Quick Install Guide
- ⑨ 2-in-1 RAID mode change and drive removal tool

IMPORTANT INFO: Please save your packaging. In the event that the drive should need to be repaired or serviced, it must be returned in its original packaging.

1.3. Views of the Drive

■ 1.3.1. Front View

The blue button (A) on the front of the LaCie 2big serves as an LED drive status indicator and the LaCie Shortcut Button.

See the LaCie Shortcut Button User Manual on the Shortcut Button CD-ROM for more information.

See troubleshooting section [4.2. LED Indicators](#) for more information.

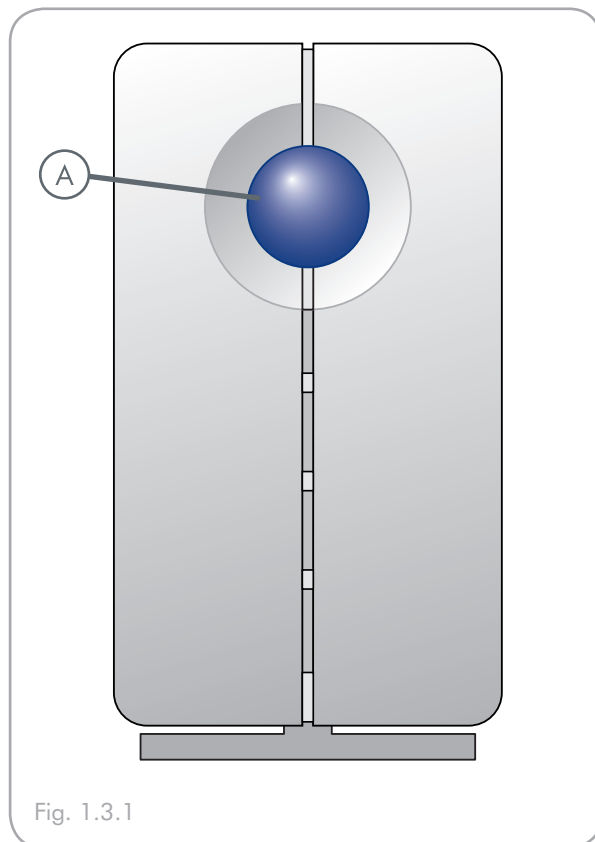
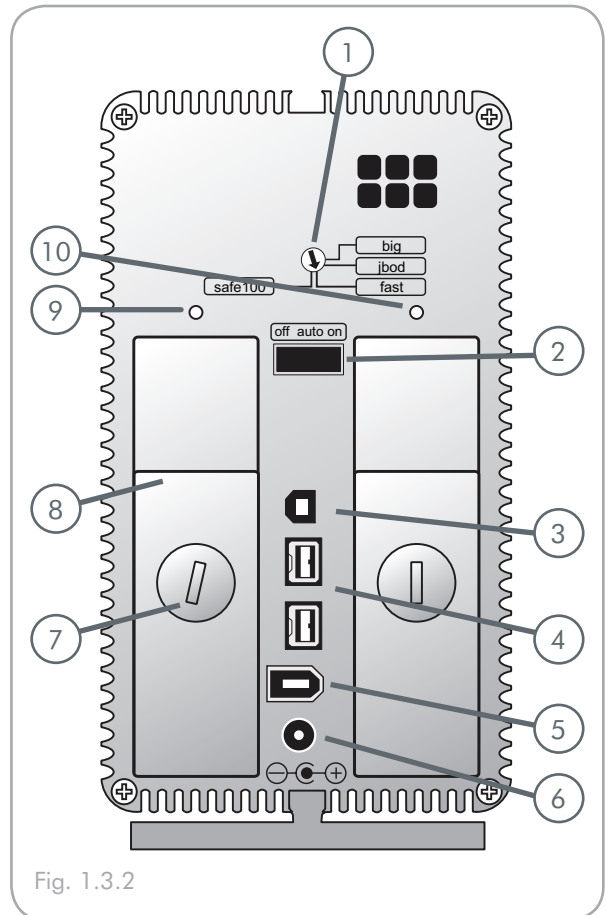

Fig. 1.3.1

■ 1.3.2. 2big Triple Rear View

- ① RAID selection switch
- ② off/auto/on power switch
- ③ USB 2.0 port
- ④ FireWire 800 ports
- ⑤ FireWire 400 port
- ⑥ Power input connection
- ⑦ Drive lock
- ⑧ Drive tray handle
- ⑨ Left drive status LED
- ⑩ Right drive status LED



CAUTION: To avoid overheating, the LaCie 2big should be installed in a well-ventilated area and in such a way as to maintain sufficient airflow across the controller chips. Also ensure that the Ventilation Fan is not obstructed.

Please use the included plastic stands and rubber feet which elevate the Two Big and allow for better heat dissipation.

Environmental Requirements:

Temperature: 0 – 35° C (32 – 95° F)

Operation Humidity: 20 – 80%, non-condensing

Storage Humidity: 10 – 90%, non-condensing

1.4. Cables and Connectors

■ 1.4.1. Hi-Speed USB 2.0

USB is a serial input/output technology for connecting peripheral devices to a computer or to each other. Hi-Speed USB 2.0 is the latest implementation of this standard, and it provides the necessary bandwidth and data transfer rates to support high speed devices such as hard drives, CD/DVD drives and digital cameras.

USB 2.0 Cables

Your LaCie drive is shipped with a Hi-Speed USB 2.0 cable to ensure maximum data transfer performance when connected to a Hi-Speed USB 2.0 port.

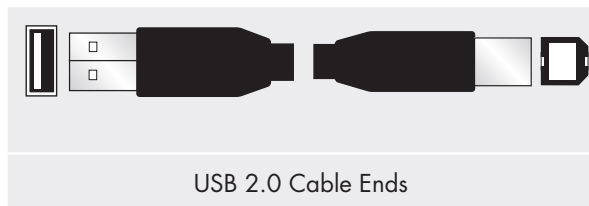

TECHNICAL NOTE: To achieve USB 2.0 speeds, your drive must be connected to a USB 2.0 host port. If it is connected to a USB 1.0 port, your drive will operate at USB 1.0 speeds.

■ 1.4.2. FireWire

FireWire 400, also known as IEEE 1394, is a high-speed serial input/output technology for connecting peripheral devices to a computer or to each other, and FireWire 800 is the implementation of the new IEEE 1394b standard.

FireWire 800 offers increased bandwidth and extended distance between devices. FireWire 800 is ideal for bandwidth-intensive applications, such as audio, video and graphics.

FireWire Cables

There are two categories of FireWire cables on the market: FireWire 800 cables, which feature the 9-to-9-pin, 9-to-6-pin, and 9-to-4-pin cables; and the original FireWire cables which feature the 6-to-6-pin and 6-to-4-pin cables.

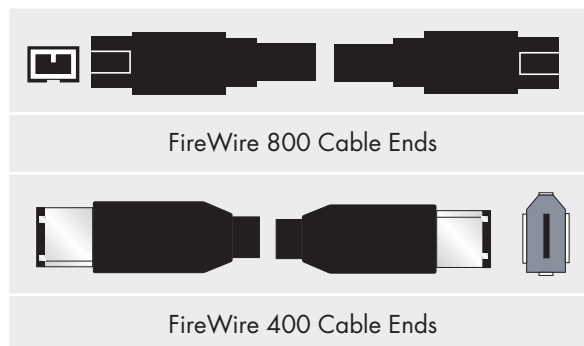

2. Setting Up Your LaCie 2big

This section covers the installation and configuration of your LaCie 2big. Follow the steps below to power on and configure your LaCie 2big:

Step 1	2.1. Connecting the Interface Cable	Page 12
Step 2	2.2. Turning the Drive On	Page 13
Step 3	2.3. Formatting – Format the drives to suit your storage needs. For more information about file system formats, see section 2.3.1. File System Formats .	Page 14

2.1. Connecting the Interface Cable

1. Plug one end of the interface cable (USB or FireWire) into the corresponding port on your host computer (Fig. 2.1-A).
2. Connect the other end of the cable to the matching port on the 2big (Fig. 2.1-B).

If two interfaces are connected at the same time, the first one connected remains active and the second will not work.

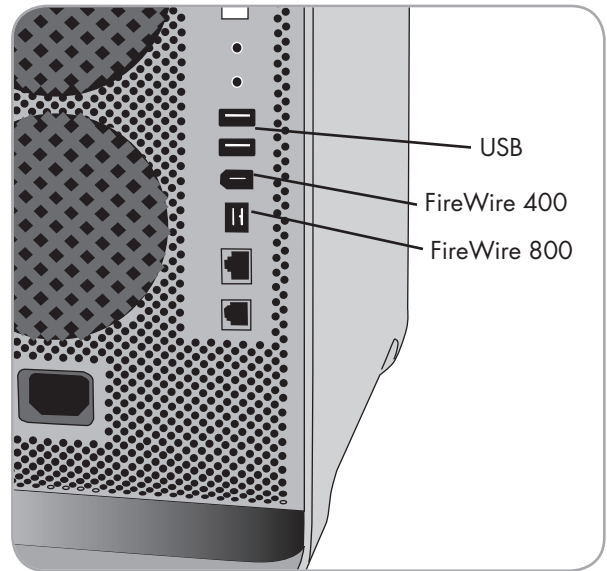

Fig. 2.1-A

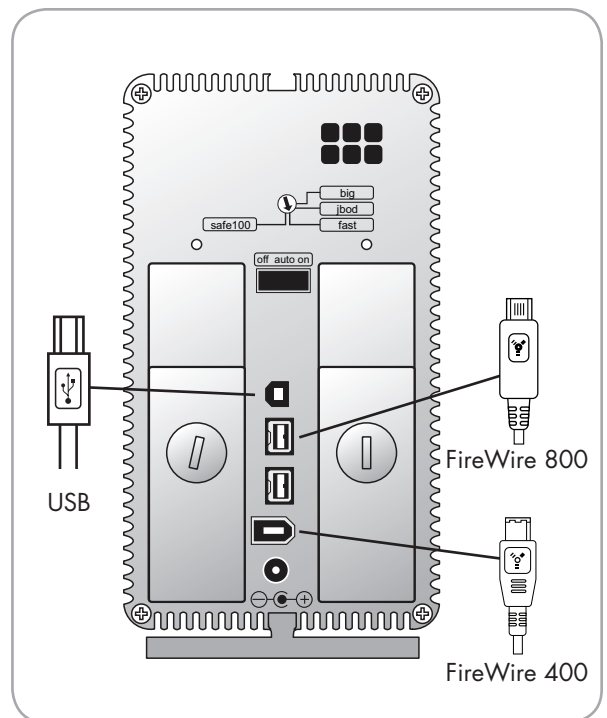

Fig. 2.1-B

2.2. Turning the Drive On

The power supply kit is composed of two cables: one cable (A) connects to the LaCie drive; and the other cable (B) connects to a power outlet, such as a wall outlet or a surge protector.

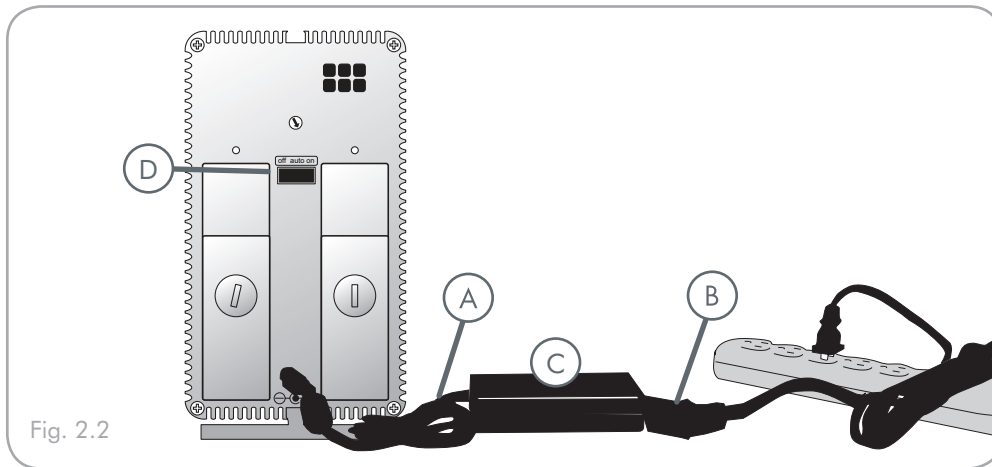





Fig. 2.2

1. Connect Cable **A** to your LaCie Drive.
2. Connect Cable **B** to the power supply brick (**C**).
3. Connect Cable **B** to a surge protector or wall outlet.
4. Turn on the drive by moving the power switch on the back of the drive to the “On” position (**D**). During drive initialization, the front led blinks blue and red. The 2big Triple is ready to use when the LEDs are solid blue. The volumes will appear in My Computer (Windows) or on the desktop (Mac).

 **TECHNICAL NOTE:** When the power switch is in the AUTO position, the 2big Triple turns off and on with your computer.

 **CAUTION:** Only use the AC adapter supplied with your specific LaCie drive. Do not use a power supply from another LaCie drive or another manufacturer. Using any other power cable or power supply may cause damage to the device and void your warranty. Always remove the AC adapter before transporting your LaCie drive. Failure to remove the adapter may result in damage to your drive and will void your warranty.

 **TECHNICAL NOTE:** You may use your LaCie drive when in a foreign country thanks to its 100-240 Volt power supply. To be able to use this feature, you may need to purchase an appropriate adapter or cord. LaCie accepts no responsibility for any damage to the drive resulting from the use of an inappropriate adapter. Using an adapter other than one authorized by LaCie will void your warranty.

2.3. Formatting

The 2big Triple comes pre-formatted in HFS+ (optimized for Mac OS X). Please read the following information on file system formats for Windows and Mac operating systems to determine if you need to reformat the 2big's disks. See sections [2.3.2](#) and [2.3.3](#) for formatting instructions.

■ 2.3.1. File System Formats

■ Windows Users

The 2big Triple comes pre-formatted in HFS+ (optimized for Mac OS X). For use with both Mac and PC, you will need to reformat to FAT 32.

FAT 32

FAT is an acronym for File Allocation Table, which dates back to the beginnings of DOS programming. Originally, FAT was only 16 bits, but after the second release of Windows 95 it was upgraded to 32 bits, hence the name FAT 32. In theory, FAT 32 volume sizes can range from less than 1MB all the way to 2TB. It is the native file system of Windows 98 and Windows Me, and is supported by Windows 2000, Windows XP and Windows Vista. When FAT 32 is used with Windows 2000, Windows XP and Windows Vista though, volume size is limited to 32GB (by the Windows partition utility, i.e. Disk Manager), and the individual file size is limited to 4GB.

NTFS

This acronym stands for New Technology Filing System, and it is the native file system for Windows NT, Windows 2000, Windows XP and Windows Vista. NTFS offers several features that are not available with FAT 32; i.e. file compression, encryption, permissions, and auditing, as well as the ability to mirror drives and RAID 5 capabilities. The minimum supported volume size for NTFS is 10MB, with a maximum of 2TB, with no limit to file size. Volumes created in NTFS can only be directly accessed (not through shares) by Windows NT, Windows 2000, Windows XP and Windows Vista without resorting to help from third-party products.

Guidelines for Choosing FAT 32 Or NTFS

Use FAT 32 if:

- ❖ You want to access your data on any operating system - FAT 32 is compatible with Windows 98 SE, Me, 2000, XP, Vista, NT, Mac OS 9.x and Mac OS X 10.x.
- ❖ You will be dual booting with an operating system other than Windows NT or Windows 2000.
- ❖ You may need the ability to dual boot down the line. Once you have converted a volume from NTFS, there is no going back. You can convert from FAT 32 to NTFS, but not the other way around.

Use NTFS if:

- ❖ You want to optimize drive performance under Windows 2000, Windows XP or Windows Vista.
- ❖ You want to encrypt files, assign permissions to files, or want to audit files for access.
- ❖ You will be formatting partitions larger than 32GB.
- ❖ You need to store individual files that are larger than 4GB.
- ❖ You need a filing system that can be mirrored or structured like a RAID 5 configuration.

■ Mac Users

The **LaCie 2big Triple** comes preformatted in HFS+ for optimum performance with Mac OS X.

Mac OS X Users:

You may customize the drive by reformatting and/or partitioning the drive with separate file system formats. For optimal performance in Mac OS environments, format and partition the drive as one large Mac OS Extended volume.

Mac OS Extended (HFS+)

Mac OS Extended refers to the file system used by Mac OS X. HFS+ represents an optimization of the older HFS file system by using hard disk space more efficiently. With HFS+, you are no longer limited by block size.

MS-DOS File System (FAT 32)

This is the Microsoft file system, more typically known as FAT 32. This is the file system to use if you are going to be using your LaCie Hard Drive between Macs and Windows operating systems.

■ 2.3.2. Formatting for Windows Users

The process of formatting a drive on a computer running Windows 2000, Windows XP or Windows Vista consists of two steps: (1) installing a signature on the drive, and (2) formatting the drive. These steps will erase anything that is on the disk.

1. Connect the drive to the computer via the interface port.
2. Right-click **My Computer** and select **Manage**.
3. From the “Computer Management” window, select **Disk Management** (located below the **Storage** group). See Fig. 2.3.2.A.
4. If the “Initialize and Convert Disk Wizard” window appears, click **Cancel**.
5. Windows will list the Hard Disks that are installed on the system. Locate the drive that is represented by the  icon. Right-click the icon and select **Initialize**.
6. In the box to the right that says **Unallocated**, right-click and select **New Partition...**
7. On the first page of the “New Partition Wizard,” click **Next**. See Fig. 2.3.2.B.

■ (continued on next page)

CAUTION: Following these steps will erase everything from the 2big. If you have information that you want to protect or continue to use, back up this information before performing these steps.

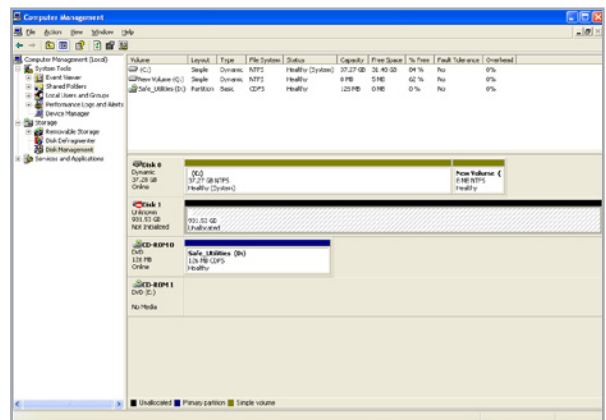

Fig. 2.3.2.A

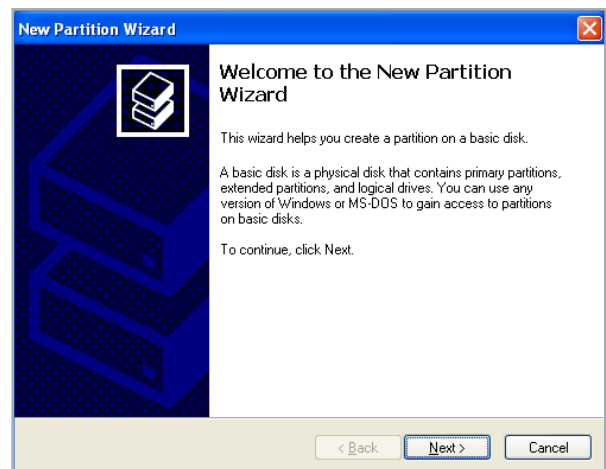

Fig. 2.3.2.B

8. Click **Next**.
9. Click **Next**.
10. Click **Next**.
11. Click **Next**.
12. On the Format Partition window, select **Quick Format**. Click **Next**.

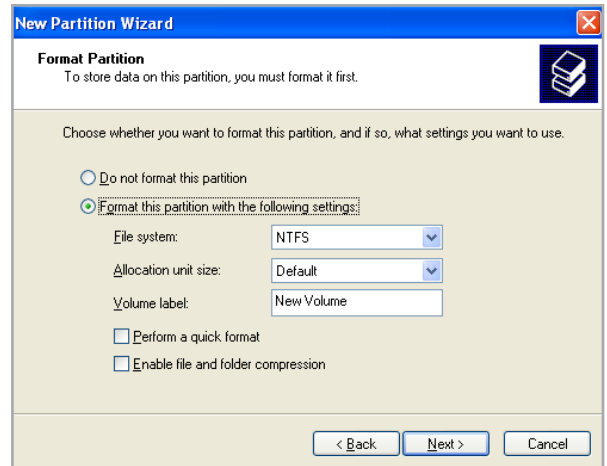

Fig. 2.3.2.C

13. Click **Finish** to begin the formatting process.
14. Windows Disk Management will format and partition the disk according to your settings (Fig. 2.3.2.D.), and your drive will appear in **My Computer**, ready to use.

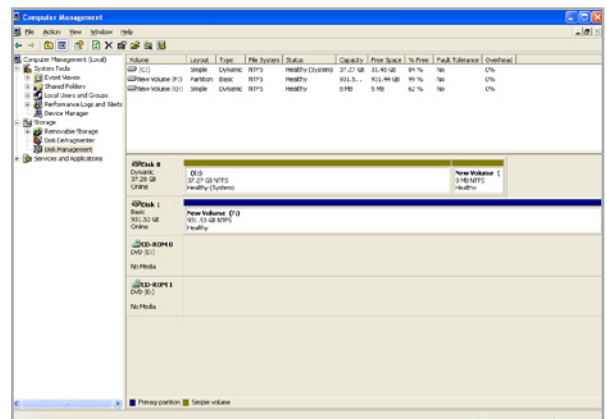

Fig. 2.3.2.D

IMPORTANT INFO: Please refer to section [2.3.1. File System Formats](#), for a more detailed comparison of the various file system formats.

■ 2.3.3. Formatting for Mac Users

1. Connect the drive to the computer and turn on the drive.
2. Select **Utilities** from the **Go** menu in the Finder menu bar.
3. In the Utilities folder, double-click **Disk Utility**.
4. The Disk Utility window will open. Select the volume labeled **LaCie Hard Disk** from the list of available hard disks on the left side of the window.
5. Select the **Partition** tab.
6. From the **Volume Scheme:** menu, choose the number of partitions you want to divide the drive into (Mac OS X gives you the option of dividing the drive into at most 16 partitions). You can adjust the size of each partition using the slide bar between the partitions in the **Volume Scheme:** area.
7. In the **Volume Information** section, enter a name for each volume (partition), choose the volume format.
8. Once you have finalized the volume options, click **Partition**. Click **Partition** again when the alert message appears to continue.
9. Mac Disk Utility will format and partition the disk according to your settings, and your drive will be ready to use.

CAUTION: Following these steps will erase everything from the 2big. If you have information that you want to protect or continue to use, back up this information before performing these steps.

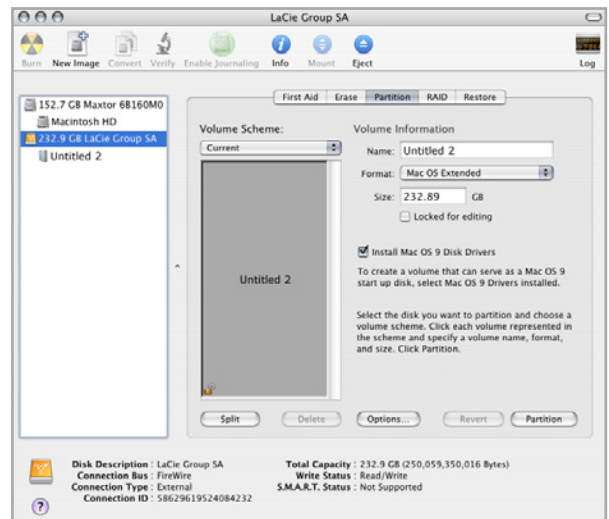

Fig. 2.3.3.

IMPORTANT INFO: Please refer to section [2.3.1. File System Formats](#), for a more detailed comparison of the various file system formats.

IMPORTANT INFO: Apple recommends that unless you have a specific reason to use the UNIX File System (UFS), you should use the Mac OS Extended format because it provides a more familiar experience to Macintosh users.

2.4. Installing New Firmware (Upgrade)

LaCie may periodically offer firmware updates for the 2big. Visit LaCie's Web site, www.lacie.com, for the latest firmware update. For the procedure, please contact LaCie technical support.

3. RAID

3.1. About 2big Triple RAID Modes

This section will help you decide which RAID mode is right for your application.

- ❖ [Fast \(RAID 0\), Section 3.1.1](#)
- ❖ [Big, Section 3.1.2](#)
- ❖ [JBOD, Section 3.1.3](#)
- ❖ [Safe 100 \(RAID 1\), Section 3.1.4](#)

TECHNICAL NOTE: Capacity varies depending upon RAID mode.

- ❖ Big, Fast and JBOD = total accessible capacity
- ❖ Safe 100 (RAID 1) = 50% capacity

■ 3.1.1. FAST (RAID 0)– Preconfigured mode of the 2big

In Fast mode, the two physical disks are striped together (RAID 0) so that one larger logical volume mounts on the desktop, offering the maximum possible capacity like in Big mode (the available capacities of each disk are cumulated) yet with greater speed than the Big mode (the speed of each disk are cumulated to a certain level).

IMPORTANT INFO: If one physical disk fails, the data of both disks become inaccessible.

Characteristics and Advantages

- ❖ Offers the maximum possible capacity
- ❖ Greater speed (than Big mode)

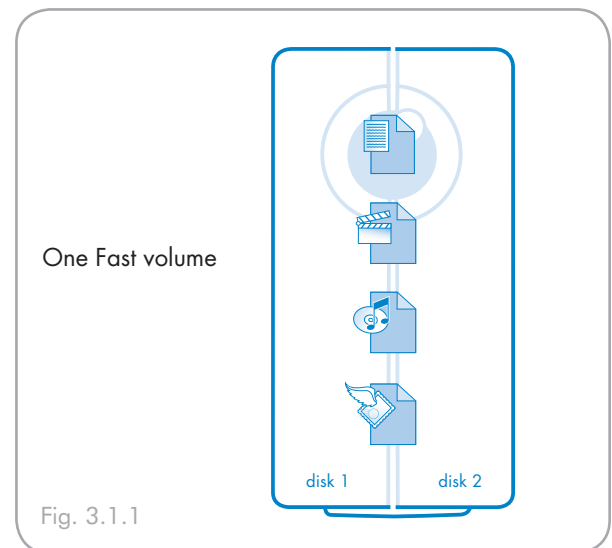

■ 3.1.2. BIG (Concatenation)

In Big mode, the two physical disks are combined (concatenation) so that one single yet larger logical volume mounts on the desktop, offering maximum possible capacity (the available capacities of each disk are cumulated).

 **IMPORTANT INFO:** If one physical disk fails, the data of both disks become inaccessible.

Offers the maximum possible capacity by combining the capacities of two drives into one large volume.

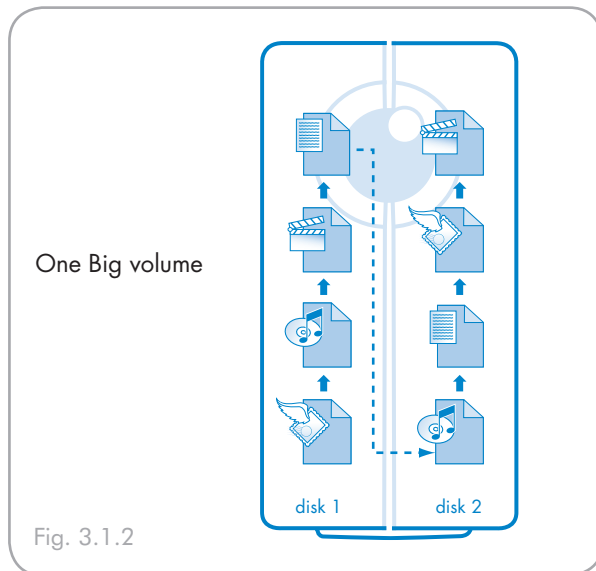

■ 3.1.3. JBOD

In JBOD mode (Just a Bunch of Disks), the two physical disks work as two independent hard drives in one single housing so that two logical volumes mount on the desktop.

 **IMPORTANT INFO:** If one physical disk fails, its data are become inaccessible, but the second disk continues to work independently.

In certain configuration, using a powerful computer with under-exploited resources, JBOD mode can be faster than Fast mode when using the native RAID 0 software of the computer operating system.

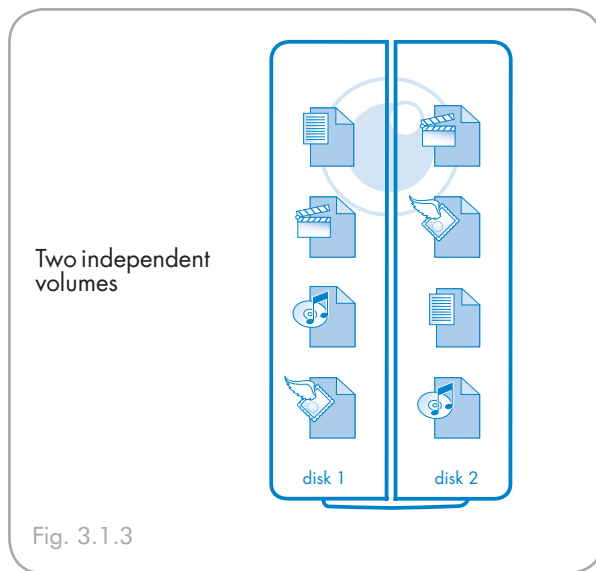

■ 3.1.4. SAFE 100 (RAID 1)

In Safe 100 mode, the two physical disks are mirrored together (RAID 1) so that one single logical volume mounts on the desktop.

All of the data (100%) are saved simultaneously on each disk (the available capacity cannot exceed the available capacity of the lowest-capacity single disk).

 **IMPORTANT INFO:** If one physical disk fails, the data are available immediately on the second disk. No data are lost if one disk fails.

Characteristics and Advantages

- ❖ Maximum data safety
- ❖ Safe 100 reduces the total available capacity by 50% because two copies of the data are saved.

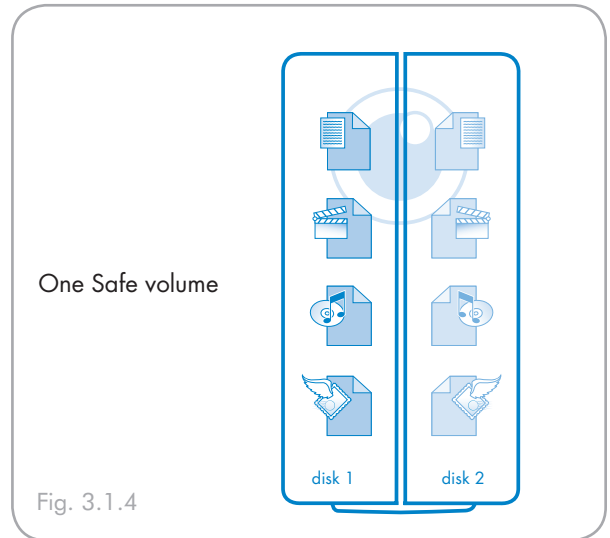

3.2. Changing the RAID Mode

Before you change the RAID mode of the LaCie 2big, familiarize yourself with the 2big's RAID modes. See section [3.1. About 2big Triple RAID Modes](#).

IMPORTANT INFO: Changing the RAID mode destroys data stored on the LaCie 2big. If you have saved data on the drives, back up data before following these steps.

CAUTION: Disk drives must be inserted correctly in the 2big before configuration can be changed.

To change the RAID mode:

1. If there is data on the 2big you want to save, back it up to another device.
2. Unmount/safely remove the 2big and turn it off.
3. Insert a small, flat-blade screwdriver into the groove on the rotary switch and turn the screwdriver to the left or right to select a different mode (Fig. 3.2).
4. Turn on the 2big.

IMPORTANT INFO: You must partition the disk drives after changing the storage policy configuration. See section [3.3. Partitioning the LaCie 2big Disks](#).

CAUTION: Your LaCie 2big comes preconfigured in Fast (RAID 0) mode. Fast mode allows access to the whole storage capacity but does not provide any security. If a drive fails, all data will be lost. If you are concerned about data security, LaCie highly recommends a RAID 1 (Safe 100) configuration. See section [3.1. About 2big Triple RAID Modes](#), for more information.



Fig. 3.2

3.3. Partitioning the Disks

You must partition the drives after changing the 2big configuration mode (SAFE, FAST, BIG, etc). During this process, you will format the drives. For more information about file system formats, see section [2.3.1. File System Formats](#).

IMPORTANT INFO: The disks shipped with the 2big Triple are formatted HFS+. To use the drives with Mac operating systems or for cross-platform use between Mac and PC, the drives must be reformatted. For more information, see section [2.3.1. File System Formats](#).

3.3.1. Windows Users

IMPORTANT INFO: Do not partition the virtual disk that initially mounts on your OS.

This example illustrates the Fast storage policy, which optimizes the LaCie 2big for performance.

1. Right click the **My Computer** icon on your desktop and select **Manage** from the pop-up window (Fig. 3.3.1-A).
2. Select **Disk Management** under **Storage** to open the **Windows Disk Manager** (Fig. 3.3.1-B).

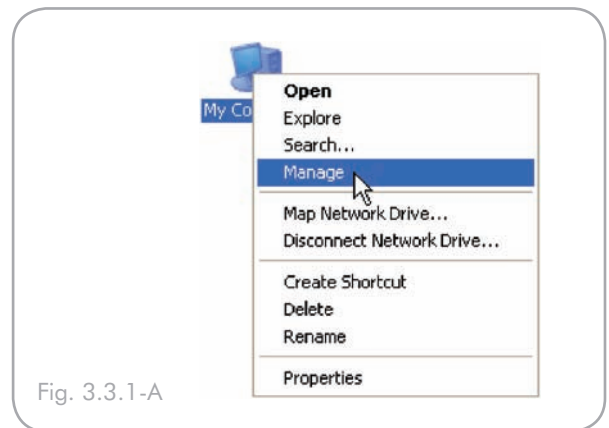

Fig. 3.3.1-A

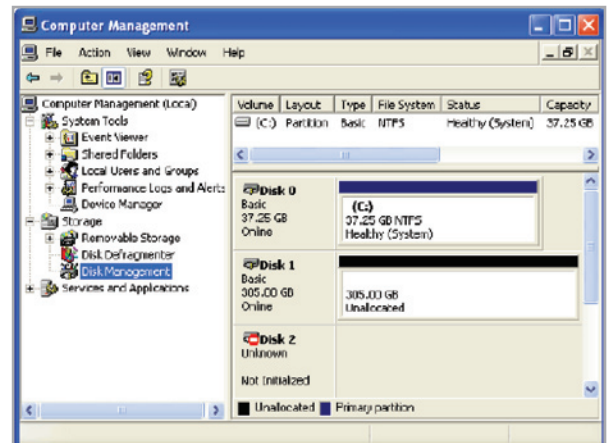

Fig. 3.3.1-B

3. Right click the configured disk's unallocated space and select **New Partition**. If the New Partition option is not available, select the disk and initialize it first (Fig. 3.3.1-C).

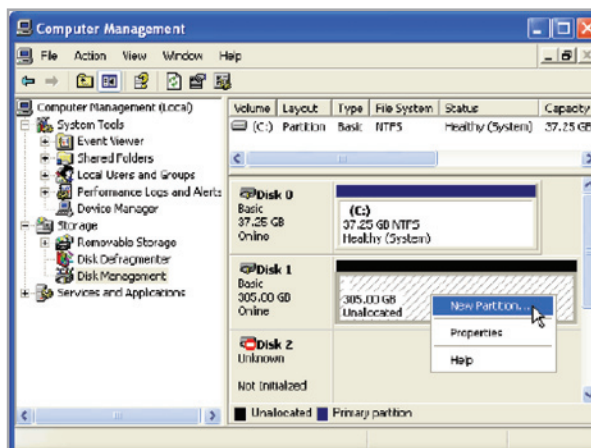

Fig. 3.3.1-C

4. Click **Next** to start the Partition Wizard (Fig. 3.3.1-D).

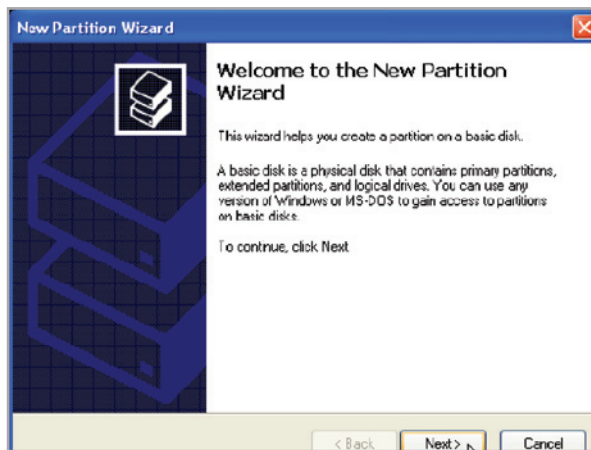

Fig. 3.3.1-D

5. Select the **Primary** or **Extended** option and click **Next** (Fig. 3.3.1-E).

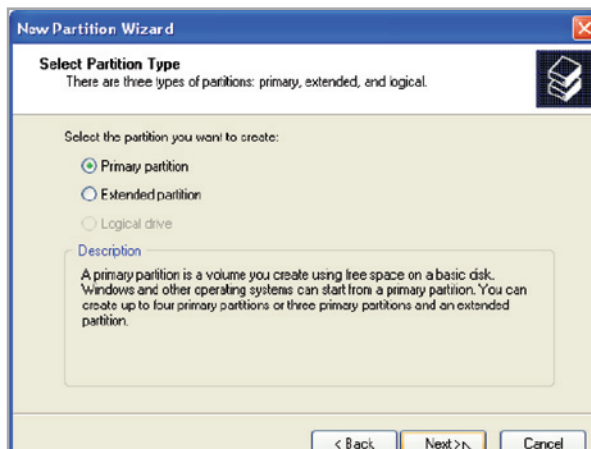

Fig. 3.3.1-E

- Specify the partition size. By default, the partition occupies the entire volume. Click **Next** (Fig. 3.3.1-F).
- Assign a drive letter or mount path and click **Next**

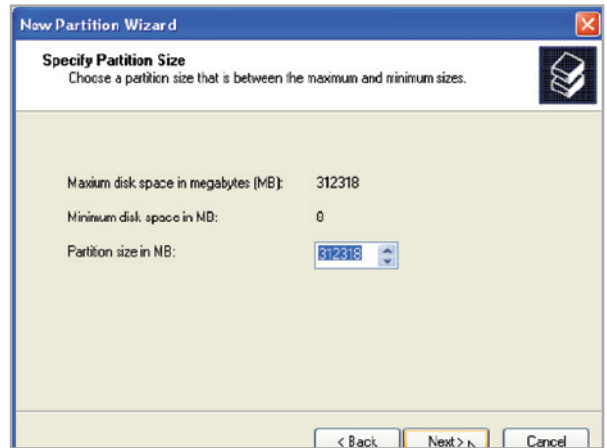

Fig. 3.3.1-F

(Fig. 3.3.1-G).

- Name and format the partition and click **Next**

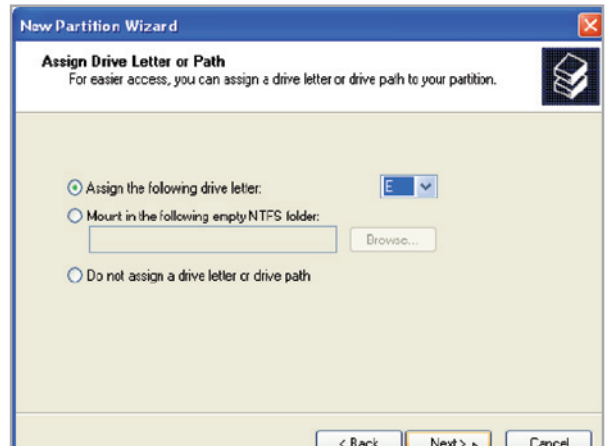

Fig. 3.3.1-G

(Fig. 3.3.1-H).

- Review the settings and click **Finish** to create the

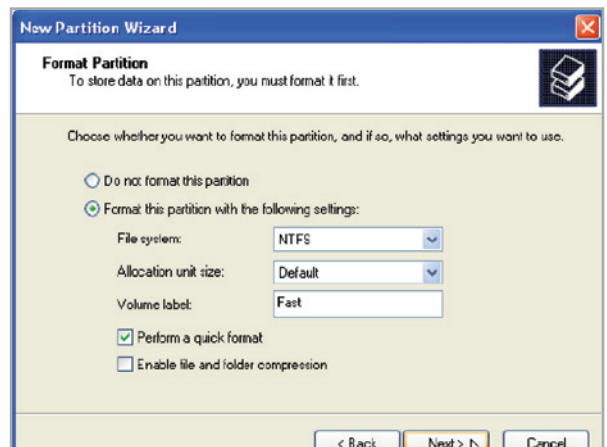

Fig. 3.3.1-H

logical partition (Fig. 3.3.1-I).

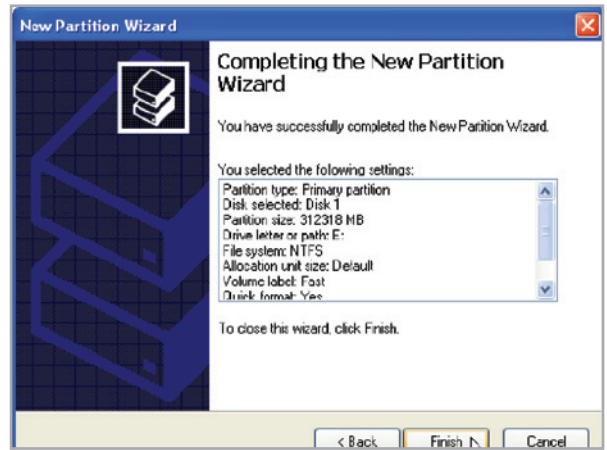

Fig. 3.3.1-I

■ 3.3.2. Mac Users

IMPORTANT INFO: Do not partition the virtual disk that initially mounts on your OS.

This example illustrates the JBOD RAID mode, which optimizes the LaCie 2big for performance when configured as a software RAID 0 on the host computer.

1. Launch **Disk Utility** from the Applications / Utilities folder (Fig. 3.3.2-A).
2. Select a configured disk and click the **Partition** tab (Fig. 3.3.2-B, red boxes).
3. Select **1 Partition** from the **Volume Scheme** drop-down list (Fig. 3.3.2-B, green box).
4. Enter a name for the volume in the Name field (Fig. 3.3.2-B, yellow box).
5. Select **Mac OS Extended (journaled)** from the **Format** drop-down list (Fig. 3.3.2-B, orange box).
6. Specify the size of the partition in the **Size** field (Fig. 3.3.2-B, light blue box).

TECHNICAL NOTE: The size of the partitions can only be changed if multiple partitions have been created.

7. Click the **Partition** button (Fig. 3.3.2-B, dark blue box).
8. Click **Partition** to acknowledge the warning (Fig. 3.3.2-C). Disk Utility mounts the created partition and represents it with an icon on the desktop. The icon is labeled with the partition name.

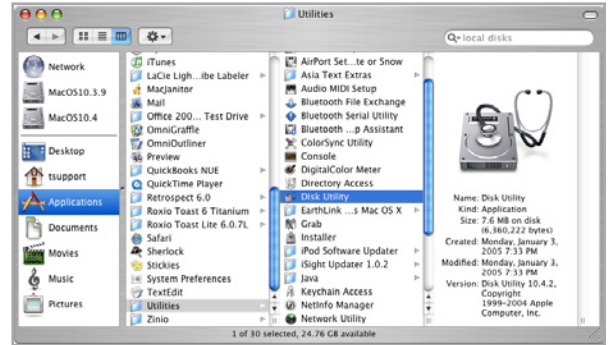

Fig. 3.3.2-A

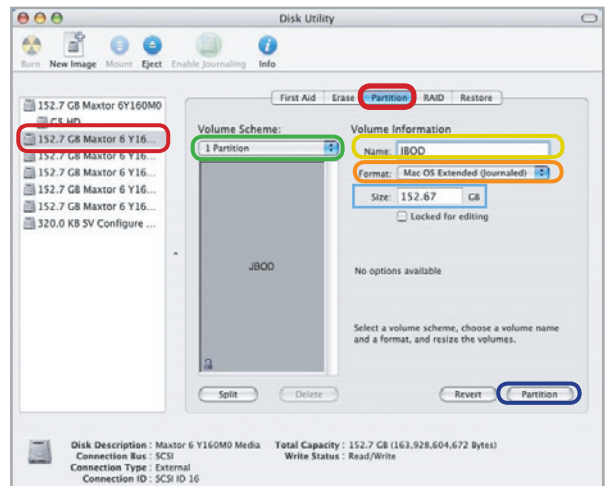

Fig. 3.3.2-B

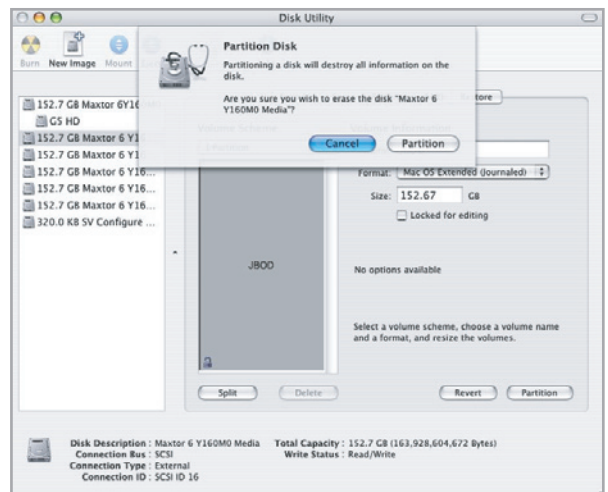



Fig. 3.3.2-C

3.4. Removing and Installing Drives

In the event that an individual hard disk fails in the LaCie 2big, please contact your LaCie reseller or LaCie Customer Support. Please replace a defective hard drive only with a new drive provided by LaCie. For drive removal and replacement process, please follow the steps below.

 **CAUTION:** After continuous use of the LaCie 2big, drives may be hot. Use caution when removing.

To Remove a Drive:

1. Turn off and unplug the LaCie 2big.
2. The drive tray may be locked. To unlock it, insert the round end of the provided 2-in-1 tool into the slot on the drive lock and turn the lock until the slot is vertical (Fig. 3.4-A).
3. Draw out the drive tray by inserting your finger into the space behind the drive tray handle and pulling to disengage the drive (Fig. 3.4-B).
4. Grasp the drive tray handle and carefully extract the drive (Fig. 3.4-C).
5. Turn the drive on to continue using the remaining drive.

To Install a Drive:

1. Turn off and unplug the LaCie 2big.
2. Carefully insert the drive tray into an empty drive bay. When the drive tray is most of the way in and you feel resistance, press the drive tray handle firmly until you feel the drive snap into place and the drive tray handle is flush with the back of the 2big.
3. Use the 2-in-1 tool to lock the drive lock. Turn the locks until the grooves are oriented vertically. The drives are locked when **both** locks are vertical.

 **TECHNICAL NOTE:** Data are still accessible during a RAID 1 rebuild. The 2big can be disconnected from the workstation during the rebuild; only the power must be connected.

IMPORTANT INFO: Drive warranty will be void if you replace the defective drive with a drive not provided by LaCie. Drives purchased from LaCie are shipped pre-installed in drive trays with handles.

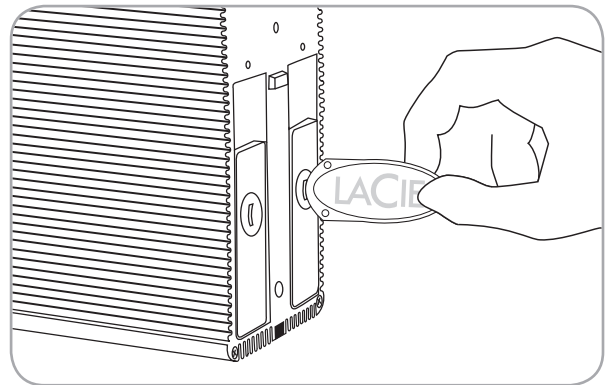

Fig. 3.4-A

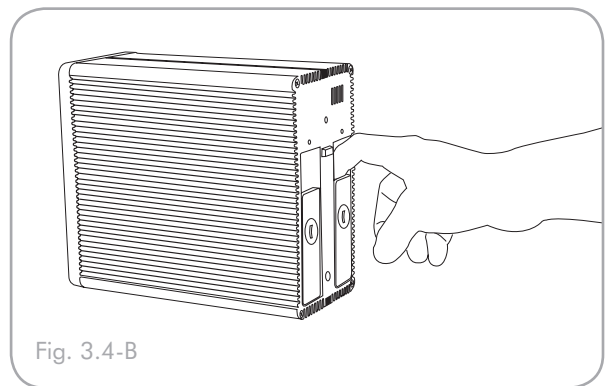

Fig. 3.4-B

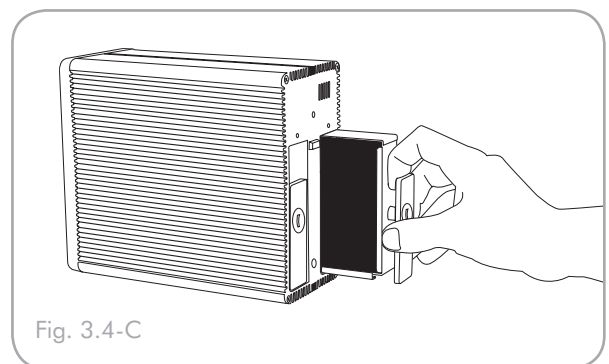

Fig. 3.4-C

4. Troubleshooting

In the event that your LaCie 2big is not working correctly, please refer to the following checklist to find out where the problem is coming from. If you have gone through all of the points on the checklist and your drive is still not working correctly, please have a look at the FAQs that are regularly published on our Web site – www.lacie.com. One of these FAQs may provide an answer to your specific question. You can also visit the drivers pages, where the most recent software updates will be available.

If you need further assistance, please contact your LaCie reseller or LaCie Technical Support (see section [5. Contacting Customer Support](#) for details).

■ Manual Updates

LaCie is constantly striving to give you the most up-to-date, comprehensive user manuals available on the market.

It is our goal to provide you with a friendly, easy-to-use format that will help you quickly install and utilize the many functions of your new device. If your manual does not reflect the configurations of the product that you purchased, please check our Web site for the most current version available.

www.lacie.com

4.1. Fan

The 2big Triple's system fan does not run continuously; it is activated at certain temperatures. If the fan is not running, verify that the power connections are active and that the 2big is on.

If the fan has malfunctioned, the front led blinks blue/red. The LED starts blinking when the board reaches a critical temperature level.

Please contact your LaCie Reseller.

4.2. LED Indicators

The LaCie 2big Triple has three LED indicators – one on the front of the drive and two on the back (one for each drive) which can indicate the current state of the 2big or problems it may be experiencing.

In normal use:

- ❖ Front LED is solid blue.
- ❖ Rear LEDs are solid blue when the 2big is inactive and blinking during drive activity.

If the front LED blinks red and blue:

1. The fan may be malfunctioning.
2. A drive may be improperly inserted.
 - a. Look at the drive LEDs on the back.
 - b. If one of the drive LEDs is also blinking red and blue, make sure the drive is properly inserted. Follow the steps in section [3.4. Removing and Installing Drives](#) to remove and re-insert the drive.
 - c. If the drive LED continues to blink red and blue after it has been re-inserted, the drive may be defective. Contact LaCie Customer Support (section [5. Contacting Customer Support](#)).
3. In RAID 1 mode (SAFE 100) a data rebuild may be in progress.
 - a. Look at the drive LEDs on the back.
 - b. If a data rebuild is in progress, the drive being rebuilt will blink red and the drive being read will blink blue.
 - c. After the rebuild, the rebuilt drive will blink blue rapidly while the 2big checks the rebuild.
4. RAID is not functioning or the 2big cannot determine the RAID setting.

In JBOD mode:

If the front LED is solid blue, but either of the drive LEDs on the back is off, the drive may be incorrectly inserted or may have failed.

1. Follow the steps in section [3.4. Removing and Installing Drives](#) to remove and re-insert the drive.
 2. If the drive LED continues to be OFF after it has been re-inserted, the drive may be defective. Contact LaCie Customer Support (section [5. Contacting Customer Support](#)).
-

4.3. LaCie 2big Host Connection

■ Problem	■ Solution
The LaCie 2big is not recognized when USB is plugged-in.	Verify the System LED status to confirm power.
	Verify HBA BIOS recognizes empty 2big.
	Turn off PCI bus power save mode in the host BIOS.
	Verify the USB connection and try a different USB cable.
	Connect to a different USB port.
Operating system does not recognize LaCie virtual drives.	Verify HBA BIOS recognizes empty LaCie 2big.
	Before reconfiguring the mode of operation, use the operating system's Disk Manager to delete partitions on the volume.
	Ensure the HBA driver is current.
	Troubleshoot driver: <ul style="list-style-type: none"> • Verify driver active status. For Windows, the Device Manager should show the SCSI icon next to the HBA. For Mac OS X, the Disk Utility should show a SCSI Connection ID for the virtual disks on the physical hard disk drives. Error messages during the driver installation would have indicated issues. • Resolve resource conflicts (IRQ, DMA, or I/O).
	Verify port multiplier (PM) support in the HBA.

5. Contacting Customer Support

■ Before You Contact Technical Support

1. Read the manuals and review section [4. Troubleshooting](#).
2. Try to isolate the problem. If possible, make the drive the only external device on the CPU, and make sure that all of the cables are correctly and firmly attached.

If you have asked yourself all of the pertinent questions in the troubleshooting checklist, and you still can't get your LaCie drive to work properly, contact us at www.lacie.com. Before contacting us, make sure that you are in front of your computer and that you have the following information on hand:

Information	Where to Find Information
1. LaCie hard drive serial number	Located on a sticker at the back of drive or on the original packaging
3. Macintosh/PC model	Mac users: Click on the Apple icon in the menu bar and select About This Mac . Windows users: Right click My Computer and select Properties > General .
4. Operating system version	
5. Processor speed	
6. Computer memory	Mac users: Click on the Apple icon in the finder bar and select About This Mac . Select More Info... The Apple System Profiler will launch and will list your internal and external peripherals. Windows users: Right click My Computer and select Properties > Hardware .
7. The brands and models of other internal and external peripherals installed on your computer	

LaCie Technical Support Contacts

LaCie Asia, Singapore, and Hong Kong Contact us at: http://www.lacie.com/asia/contact/	LaCie Australia Contact us at: http://www.lacie.com/au/contact/
LaCie Belgium Contact us at: http://www.lacie.com/be/contact/ (Français)	LaCie Canada Contact us at: http://www.lacie.com/caen/contact/ (English)
LaCie Denmark Contact us at: http://www.lacie.com/dk/contact	LaCie Finland Contact us at: http://www.lacie.com/fi/contact/
LaCie France Contact us at: http://www.lacie.com/fr/contact/	LaCie Germany Contact us at: http://www.lacie.com/de/contact/
LaCie Italy Contact us at: http://www.lacie.com/it/contact/	LaCie Japan Contact us at: http://www.lacie.com/jp/contact/
LaCie Netherlands Contact us at: http://www.lacie.com/nl/contact/	LaCie Norway Contact us at: http://www.lacie.com/no/contact/
LaCie Spain Contact us at: http://www.lacie.com/es/contact/	LaCie Sweden Contact us at: http://www.lacie.com/se/contact
LaCie Switzerland Contact us at: http://www.lacie.com/chfr/contact/ (Français)	LaCie United Kingdom Contact us at: http://www.lacie.com/uk/contact
LaCie Ireland Contact us at: http://www.lacie.com/ie/contact/	LaCie USA Contact us at: http://www.lacie.com/contact/
LaCie International Contact us at: http://www.lacie.com/intl/contact/	

6. Warranty

LaCie warrants your LaCie 2big against any defect in material and workmanship, under normal use, for the period designated on your warranty certificate. In the event this product is found to be defective within the warranty period, LaCie will, at its option, repair or replace the defective LaCie 2big.

In the event of a drive failure please contact your LaCie reseller or LaCie customer support for drive replacement procedure.

This warranty is void if:

- ❖ The LaCie 2big was operated/stored in abnormal use or maintenance conditions;
- ❖ The LaCie 2big is repaired, modified or altered, unless such repair, modification or alteration is expressly authorized in writing by LaCie;
- ❖ The LaCie 2big was subjected to abuse, neglect, lightning strike, electrical fault, improper packaging or accident;
- ❖ The LaCie 2big was installed improperly;
- ❖ The serial number of the LaCie 2big or an individual Drive Bay is defaced or missing;
- ❖ The broken part is a replacement part such as a pick-up tray, etc.
- ❖ The tamper seal on the LaCie 2big or an individual Drive Bay casing is broken.
- ❖ One or two of the hard disks have been removed and replaced by any hard disk other than a drive provided by LaCie. For drive removal/replacement process, see section [4, Removing and Installing Drives](#).

LaCie and its suppliers accept no liability for any loss of data during the use of this device, or for any of the problems caused as a result.

LaCie will not, under any circumstances, be liable for direct, special or consequential damages such as, but not limited to, damage or loss of property or equipment, loss of profits or revenues, cost of replacement goods, or expense or inconvenience caused by service interruptions.

Any loss, corruption or destruction of data while using a LaCie drive is the sole responsibility of the user, and under no circumstances will LaCie be held liable for the recovery or restoration of this data.

Under no circumstances will any person be entitled to any sum greater than the purchase price paid for the drive.

To obtain warranty service, call LaCie Technical Support. You will be asked to provide your LaCie product's serial number, and you may be asked to furnish proof of purchase to confirm that the drive is still under warranty.

All systems returned to LaCie must be securely packaged in their original box and shipped with postage prepaid.

IMPORTANT INFO: Register online for free technical support: www.lacie.com/register